

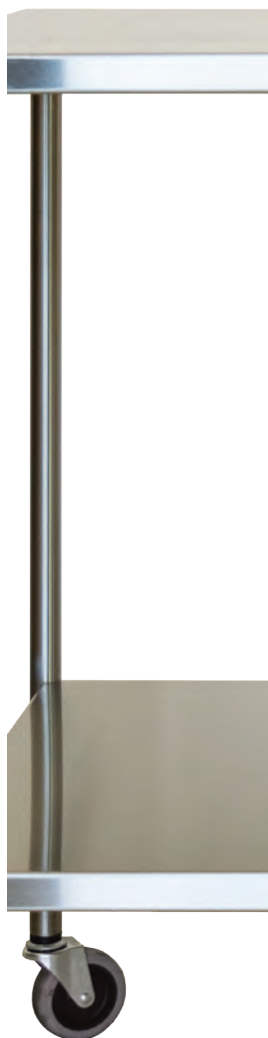

COMPLETE PRODUCT CATALOGUE

DELIVERING TOTAL HEALTHCARE VALUE SINCE 1935



OUR HISTORY IS STAINLESS



ABOUT US

Proudly Canadian and established in 1935, we are one of Canada's oldest hospital capital equipment manufacturers. With an excellent reputation and legacy for **quality products**, we are well-known as a **manufacturer of stainless steel** healthcare equipment for Sterile Processing, Operating Room, Examination and Treatment, Patient Handling, and Mortuary/ Pathology areas.

Our growing portfolio of products also has applications in Infection Control & Prevention, an important area of focus for our future.

We use superior grades of stainless steel to provide quality products you can trust. What's more? All of our products are backed by an **industry-leading warranty policy**.

In addition to the standard models found within this catalogue, **custom designs** can be configured to suit specific user requirements and constraints. The Imperial Surgical team will be pleased to assist you with an evaluation **of your needs to find the best solution**.



CONTENTS

04 WARMING CABINETS

Warming Cabinets
HugAire™

08 IV POLES

Stainless Steel IV Poles
Antimicrobial IV Poles with CuVerro Shield™

12 CARTS & CABINETS

Closed Case Carts
Open Case Carts
Utility Carts
Anesthesia Cart
Instrument / Supply Cabinet

19 TABLES

Instrument Tables
Equipment Tables
Mayo Stands
Straddle (Neurosurgery) Tables
Linen Inspection Tables
Utility Inspection Table

26 MATERNITY BASSINETS

Kerri Bear Maternity Bassinet™
Stainless Steel Maternity Bassinet

30 STOOLS & CHAIRS

Stackable Step Stools
Chairs & Stools
Foot Stools
First Aid Couch
Examination Chairs & Stools

34 IMPERIAL WARE, STANDS & RECEPTACLES

Bowl Stands & Receptacles
Graduated Measuring & Gallipots
Wash Basins & Bowls
Food Service Containers
Instrument Trays
Catheter & Instrument Trays
Urinals & Bedpans
Jars & Covers
Petri Dishes
Emesis Basins
Cups, Tumblers, & Pitchers
Ancillary Items

48 SPECIALIZED EQUIPMENT

Cadaver Stretcher
Narcotic Cabinets
Curtain & Cubicle Tracks
Relton-Hall Scoliosis Operating Frame

52 SINKS & SINK SYSTEMS

Stainless Steel Sinks, Sink Stands, & Sink Counters
Kleanik™ Integra & Kleanik™ Sink Disinfection System



WARMING CABINETS

EFFECTIVE AND CONVENIENT

- Our patent-pending HEPA Filtered Circulating Air Warming Cabinets are designed for easy use, easy servicing, effective heat distribution, and maximum storage capacity.
- Our warming cabinets come in a range of 11 models to suit every possible need and application.
- They are available in both tall and tabletop formats with options for full stainless steel or glass inset doors.
- All our Warming Cabinets come with an industry-leading 7-year warranty (see page 7 for details)



THE IMPORTANCE OF PRE-WARMING

- Inadvertent perioperative hypothermia is a relatively common occurrence with anesthesia and can have a significant adverse impact on patients' outcomes.
- Prewarming, as recommended in the AWMF guidelines, results in a significant and clinically relevant reduction in the incidence of inadvertent perioperative hypothermia.
- Our warming cabinets provide passive warming methods to maintain temperatures throughout the perioperative process.
- Resulting benefits: reduced blood loss, shorter hospital stays, and decreased surgical site infections.



SUPERIOR AIR CIRCULATION

- With a circulating air system, our cabinets allow for the most effective and even air distribution.
- The HEPA Air Filters provide for higher quality, filtered hot air with the muffin fan system pushing down rising hot air.
- Full back panel with low wattage tubular elements.

*Data on file.

¹Bindu B, Bindra A, Rath G. Temperature management under general anesthesia: Compulsion or option. J Anaesthesiol Clin Pharmacol. 2017;33(3):306-316.

²Grote R, Wetz AJ, Bräuer A, Menzel M. Prewarming according to the AWMF S3 guidelines on preventing inadvertent perioperative hypothermia 2014 : Retrospective analysis of 7786 patients. Anaesthesist. 2018 Jan;67(1):27-33..

³Amy K. Williams, DNP, RN. Benefits of Passive Warming on Surgical Patients Undergoing Regional Anesthetic Procedures. Volume 33, ISSUE 6, P928-934, December 01, 2018.

KEY FEATURES

CABINET DESIGN

- Cabinet bodies and interior components are fully welded stainless steel with a #4 polished finish and insulated with an R-6 rating
- Doors are low maintenance fully insulated stainless steel with a high-temperature rubber gasket and magnetic insert for an air-tight seal which prevents of heat loss
- Perforated stainless steel interior shelves provide excellent weight capacity while allowing for air circulation
- Adjustable interior shelves with stops to prevent tipping and accidental removal
- Reversible hinge assembly facilitates both left and right opening configurations
- Adjustable exterior leveling feet
- All electronic components are easily accessible for maintenance



INTERIOR SHELVES

NEW! ANTIMICROBIAL HANDLES

- Our cabinet handles are now protected with CuVerro Shield™ by Aereus Technologies*
- CuVerro Shield™ is a unique solid functional layer of naturally antimicrobial copper that is applied to our warming cabinet handles to deliver outstanding protection to your highest touch zones.
- CuVerro® kills more than 99.9% of bacteria.

HEPA filtered circulating air
PATENT PENDING



NEW!
ANTIMICROBIAL
HANDLE

TEMPERATURE CONTROL

- Digital temperature controls are easy to use and precise to within +/- 1.5°C (+/- 2.7°F)
- Units with two compartments feature a unique thermostat for each
- Standard maximum temperature selection is 71°C / 160°F
- Equipped with a high-temperature overload switch for auto-shut off should an electrical malfunction occur
- High temperature warning light activated should temperature exceed the pre-selected setting by 6°C / 10°F
- Optional lockable temperature settings for enhanced safety

OR-7854

ALL MODELS AVAILABLE WITH
FULL STAINLESS STEEL OR
GLASS INSET DOORS

* CuVerro Shield™ by Aereus Technologies is a Health Canada Pest Management Regulatory Agency (PMRA) registered product.
 **Laboratory testing shows that, when cleaned regularly, CuVerro surfaces kill greater than 99.9% of the following bacteria within 2 hours of exposure: Methicillin-Resistant Staphylococcus aureus, Staphylococcus aureus, Enterobacter aerogenes, Pseudomonas aeruginosa, E.coli 0157:H7, and Vancomycin-Resistant Enterococcusfaecalis (VRE). The use of CuVerro® bactericidal copper products is a supplement to and not a substitute for standard infection control practices; users must continue to follow all current infection control practices, including those practices related to cleaning and disinfection of environmental surfaces. This surface has been shown to reduce microbial contamination, but it does not necessarily prevent cross contamination.

LOOKING FOR A MINIATURE TABLE TOP?

Specifically designed for clinics, procedure rooms, and day/ambulatory surgery centers, our HugAire™ model includes the same key features as our traditional models offering a compact and economical format. Our warming cabinet is designed for long lasting performance and for the functionality of your space.

UNIQUE FEATURES TO HUGAIRE™

- Crafted with durable powder-coated steel for long-lasting performance and an aesthetically pleasing appearance.
- The interior is expertly fabricated using 304 stainless steel, ensuring optimal hygiene and durability for long-term use.
- Features a full glass door for content visibility and durability



HEPA filtered circulating air
PATENT PENDING
OR-9000

PRODUCT SELECTION

ITEM # Stainless Steel Door	ITEM # Glass Door	DESCRIPTION	DIMENSIONS (W x D x H) IN / MM	CAPACITY (CU. FT.)	NUMBER OF SHELVES	SHELF DIMENSIONS (W x D) IN / MM
OR-7054	OR-8054	SINGLE COMPARTMENT COUNTER-TOP MODEL	29" x 20" x 34" (737 x 508 x 864)	5.2	1	24.25" x 14" (616 x 356)
OR-7154	OR-8154	SINGLE COMPARTMENT COUNTER-TOP MODEL	29" x 26" x 34" (737 x 559 x 864)	7.2	1	24.25" x 16" (616 x 406)
OR-7754	OR-8754	SINGLE COMPARTMENT	29" x 22" x 74" (737 x 660 x 1880)	14.6	3	24.25" x 20" (616 x 508)
OR-7854	OR-8854	SINGLE COMPARTMENT	29" x 28" x 74" (737 x 660 x 1880)	19.8	3	24.25" x 22" (616 x 559)
OR-7954	OR-8954	DOUBLE COMPARTMENT	29" x 28" x 74" (737 x 660 x 1880)	UPPER 4.3 LOWER 13.8	3	24.25" x 22" (616 x 559)
	OR-9000	SINGLE COMPARTMENT	23.4" x 15.2" x 19" (594 x 386 x 483)	2	1	17" x 15.1" (686 x 384)

In the event you do not have a counter available, the counter top models (OR-7054, OR-8054, OR-7154 & OR-8154) are available with a stand (OR-7995) specifically designed to support the weight of a counter top warming cabinet. Contact us for more details.

Modify your existing Warming Cabinet with our NEW CuVerro Shield™ handles

ITEM #	DESCRIPTION
CUV-3981	1 CUVERRO SHIELD™ FLUSH-PULL HANDLE
CUV-3982	2 CUVERRO SHIELD™ FLUSH-PULL HANDLES

PRODUCT SPECIFICATIONS

HUGAIRE™ DETAILS

CONSTRUCTION	
Exterior Material	Power Coated Mild Steel
Interior Material	304 stainless steel
Compartments	1
Shelves	1 W
Window	Plexiglass, full length
HEATING SYSTEM	
Convection Electric with circulating fan	
Heating Power, W	370-1,1050
Accuracy	± 1.5 C° (2.7 F°)
Displays	C°, F°
Temperature selection range	30-71 C° (86-160 F°)
Alarm Limits	High, 71C° (160 F°), Low 30C° (86 F°)
ALARM	
Visual	
Display	LED
SAFETY	
Automatic shutoff when temperature exceeds 20% above set point	
CONTROL PANEL	
Type	Digital
Display Type	LED
Indicators	Control panel, on/off analog set point
DIMENSIONS (WxDxH)	
23.4"x15.2"x19" 59.4cm x 38.6cm x 48.2cm	
CAPACITY	
2 cu.ft.	
WEIGHT	
36.3 kg (80 lb)	
LINE POWER, VAC	
110-120	
STANDARDS	
CSA, UL	
ACCESSORIES	
Half Basket, Full basket	

ELECTRICAL DETAILS

ITEM #	ELECTRICAL DATA
OR-7054 OR-7154 OR-8054 OR-8154	Service required: 120V, 60Hz Amperage: 3.1 Amps 370 Watts
OR-7754 OR-7854 OR-8754 OR-8854	Service required: 120V, 60Hz Amperage: 6.0 Amps 700 Watts
OR-7954 OR-8954	Service required: 120V, 60Hz Amperage: 9.0 Amps 1050 Watts
OR-9000	Service required: 120V, 60Hz Amperage: 1.67 Amps 200 Watts

220 volts can be made available with a stepdown transformer.

Hospital grade power cord length 72"/185cm

HEPA filtered circulating air
PATENT PENDING



Warranty Terms: First year covers parts and labor, the remaining 6 years covers parts only. The warranty is comprehensive and includes all components. The stainless steel cabinet is warranted for 7 years against manufacturing defects.

At Imperial Surgical Ltd., we have two types of IV Poles to offer. Our versatile modular design means you simply select the type and the components that work best for your needs. All of our IV Poles and components are backed by an industry leading 10 year warranty against manufacture defects.

CHOOSE AMONGST

- Our traditional **Stainless Steel IV Poles**, made from 300 grade stainless steel that is easy to clean and disinfect
- Our **NEW Antimicrobial IV Poles**, made from the same high-quality stainless steel and protected with PMRA and EPA registered **CuVerro Shield™** by **Aereus Technologies**

STAINLESS STEEL IV POLES

ITEM #	DESCRIPTION
OR-36770	IV POLE, CENTRE COLLAR, AND KNOB with 23" cream aluminium base (V-40016), and 2" casters
OR-36760-25	IV POLE, CENTRE COLLAR, AND KNOB with 25" stainless steel base (V-40013-25), and 2" casters
OR-36760-253	with 25" stainless steel base (V-40013-25), and 3" casters
OR-36771-25	IV POLE, CENTRE COLLAR, AND KNOB with 25" stainless steel base (V-40013-25), and 2" casters, and weight kit of 13.5 lbs. (V-50004-25)
OR-36771-253	with a 25" stainless steel base (V-40013-25), and 3" casters, and weight kit of 13.5 lbs. (V-50004-25)
OR-36772-253-UHN	IV POLE, CENTRE COLLAR, AND KNOB with 25" steel base (V-40014-25-ST), and 3" casters
OR-36790	IV POLE SUSPENSION POLE AUTO-CLUTCH adjustable height from 33" - 57" Recommended for ceiling up to 11 ft. w

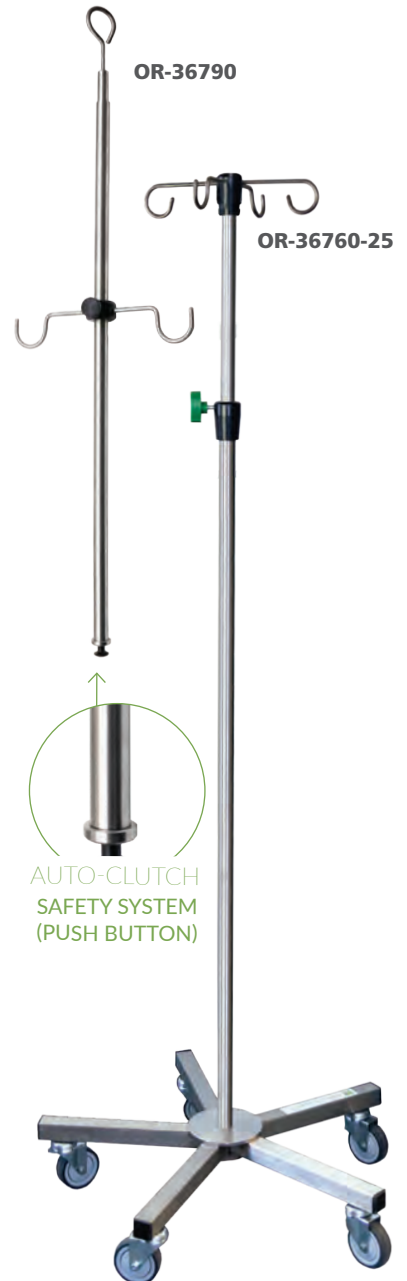

HOOKS & RAM HORNS
HEAVY-DUTY RAM HORNS, U-HOOKS
OR A COMBINATION OF BOTH
AVAILABLE



COLOUR-CODING OFFERED FOR
QUICK IDENTIFICATION BY
DEPARTMENT

POLES & HANDLES
EASILY CLEANED AND
DISINFECTED. RESISTS RUST
AND PITTING



THE LARGE PRONG KNOB FOR
HEIGHT ADJUSTMENT IS EASY TO
TURN EVEN WITH WET HANDS

BASES & CASTERS
OPTIONAL WEIGHT KIT AVAILABLE
FOR INCREASED STABILITY



SMOOTH-ROLLING
NON-MARKING
DURABLE CASTERS

AUTO-CLUTCH
SAFETY SYSTEM
(PUSH BUTTON)

HOOKS & RAM HORNS

ITEM #	DESCRIPTION
OR-36499	STAINLESS STEEL RAM HORNS, AND ENDCAP Set of 2
OR-36500	STAINLESS STEEL RAM HORNS, AND ENDCAP Set of 4
OR-36501	STAINLESS STEEL U-HOOKS, AND ENDCAP Set of 2
OR-36502	STAINLESS STEEL U-HOOKS, AND ENDCAP Set of 4
OR-36504	RAM HORNS (2), U-HOOKS (2), AND ENDCAP Set of 4
OR-36503H	RAM HORN SET/SUSPENSION POLE
OR-36503U	U-HOOK SET/SUSPENSION POLE
V-50002	URINARY DRAIN HOOK, AND COLLAR WITH KNOB Set of 1

*U-Hook & Ram Horn sold separately



OR-36504



OR-36499

HANDLES



V-50003 BLACK STEEL ROUND HANDLE



V-50006 STAINLESS STEEL TRIANGULAR HANDLE



V-50007 CREAM SEMI-ROUND HANDLE

BASES & CASTERS

ITEM #	DESCRIPTION
V-12007	CASTERS 2" GRIP RING STEM OR-36770. Used on V-40016
V-12001	CASTERS 2"/HOLE/GREY OR-36760-25,OR-36771-25
V-12003	CASTERS 3" OR-36760-253,OR-36771-253
V-40013-25	STAINLESS STEEL BASE 25" base. Sold without casters
V-40016	ALUMINIUM BASE, CREAM 23" base. Sold without casters



V-40014-25-ST



V-40013-25



V-40016

ANTIMICROBIAL IV POLES WITH CUVERRO SHIELD™

Frequently touched surfaces like IV poles have long been identified as reservoirs for the spread of pathogenic microbes.¹ These can easily contaminate the hands and equipment of healthcare professionals who in turn can transmit these pathogens to patients during routine care leading to Healthcare-associated infections.

Our Antimicrobial IV Poles protected with CuVerro Shield™ by Aereus Technologies* offers you a solution to this problem.

CuVerro Shield™ is a unique thermal fabrication of naturally antimicrobial copper that is applied to our stainless steel poles, ram horns, and u-hooks to deliver outstanding protection to your highest touch zones.

The result? CuVerro® kills more than 99.9% of bacteria** within two hours and continues to kill 99% of bacteria** even after repeated contamination.

A US government funded study conducted by researchers at the US National Institutes of Health and the Centers for Disease Control and Protection found that the HCoV-19 virus remained viable for up to 2 to 3 days on plastic and stainless steel surfaces versus up to 4 hours on copper.²



OR-36770-CUV

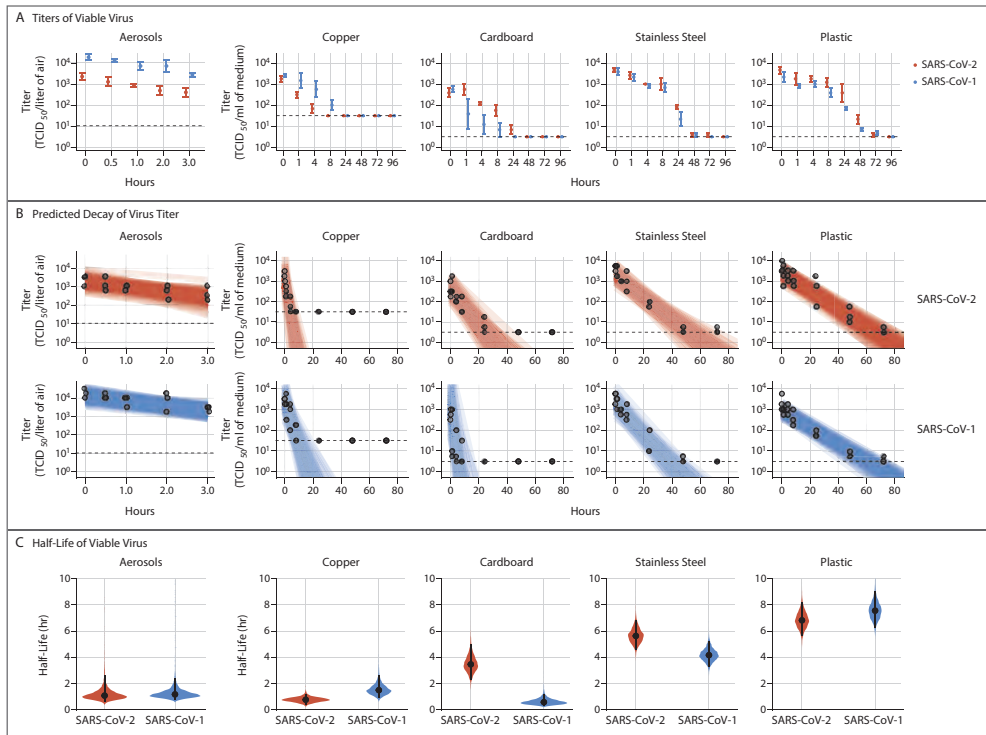

Viability of SARS-CoV-1 and SARS-CoV-2 in Aerosols and on Various Surfaces.²

* CuVerro Shield™ by Aereus Technologies is a Health Canada Pest Management Regulatory Agency (PMRA) registered product.

**Laboratory testing shows that, when cleaned regularly, CuVerro surfaces kill greater than 99.9% of the following bacteria within 2 hours of exposure: Methicillin-Resistant Staphylococcus aureus, Staphylococcus aureus, Enterobacter aerogenes, Pseudomonas aeruginosa, E.coli 0157:H7, and Vancomycin-Resistant Enterococcus faecalis (VRE). The use of CuVerro® bactericidal copper products is a supplement to and not a substitute for standard infection control practices; users must continue to follow all current infection control practices, including those practices related to cleaning and disinfection of environmental surfaces. This surface has been shown to reduce microbial contamination, but it does not necessarily prevent cross contamination.

¹Oie S, Hosokawa I, Kamiya A. 2002. Contamination of room door handles by methicillin sensitive/methicillin-resistant Staphylococcus aureus. J. Hosp. Infect. 2002;51:140-143.

²Doremalen NV, Bushmaker T, Morris DH, et al. Aerosol and surface stability of HCoV-19 (SARS-CoV-2) compared to SARS-CoV-1. N Engl J Med 2020.

BASES & CASTERS

ITEM #	DESCRIPTION
OR-36770-CUV	CuVERRO SHIELD™ IV POLE, CENTRE COLLAR, AND KNOB with 23" cream aluminium base (V-40016) and 2" casters
OR-36760-25-CUV	CuVERRO SHIELD™ IV POLE, CENTRE COLLAR, AND KNOB with 25" stainless steel base (V-40013-25) and 2" casters
OR-36760-253-CUV	with 25" stainless steel base (V-40013-25) and 3" casters
OR-36771-25-CUV	CuVERRO SHIELD™ IV POLE, CENTRE COLLAR, AND KNOB with 25" stainless steel base (V-40013-25), 2" casters, and weight kit of 13.5 lbs. (V-50004-25)
OR-36771-253-CUV	with 25" stainless steel base (V-40013-25), 3" casters, and weight kit of 13.5 lbs. (V-50004-25)
OR-36772-253-CUV	with 25" steel base (V-40014-25-ST) and 3" casters

SMOOTH-ROLLING
NON-MARKING
DURABLE CASTERS



OPTIONAL WEIGHT KIT
AVAILABLE FOR INCREASED
STABILITY

HOOKS & RAM HORNS

ITEM #	DESCRIPTION
OR-36499-CUV	CuVERRO SHIELD™ STAINLESS STEEL RAM HORNS, AND ENDCAP Set of 2
OR-36500-CUV	CuVERRO SHIELD™ STAINLESS STEEL RAM HORNS, AND ENDCAP Set of 4
OR-36501-CUV	CuVERRO SHIELD™ STAINLESS STEEL U-HOOKS, AND ENDCAP Set of 2
OR-36502-CUV	CuVERRO SHIELD™ STAINLESS STEEL U-HOOKS, AND ENDCAP Set of 4
OR-36504-CUV	CuVERRO SHIELD™ STAINLESS STEEL RAM HORNS (2), STAINLESS STEEL U-HOOK (2), AND ENDCAP Set of 4
V-50002-CUV	CuVERRO SHIELD™ STAINLESS STEEL URINARY DRAIN HOOK AND, COLLAR WITH KNOB Set of 1

CUSTOM HOOK DESIGNS
AVAILABLE TO SUIT YOUR
SPECIFIC NEEDS

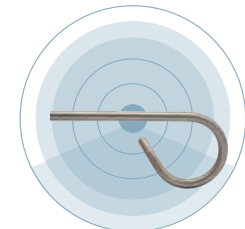

HEAVY-DUTY RAM HORNS,
U-HOOKS OR A COMBINATION
OF BOTH AVAILABLE

POLES & HANDLES

ITEM #	DESCRIPTION
V-CUV-50003	CuVERRO SHIELD™ ROUND STEEL HANDLE
V-CUV-50006	CuVERRO SHIELD™ STAINLESS STEEL TRIANGULAR HANDLE
V-CUV-50007	CuVERRO SHIELD™ SEMI-ROUND STEEL HANDLE

THE LARGE PRONG KNOB FOR
HEIGHT ADJUSTMENT IS EASY TO
TURN EVEN WITH WET HANDS

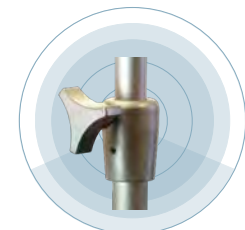

GOOD TO KNOW: In the unlikely event your CuVerro Thermal Fabrication IV Pole should become deeply scratched, a study conducted by the University of Waterloo demonstrated that antimicrobial activity of the Aereus Thermal Fabrication is maintained even when completely removed up to a width of between 3 and 5 mm, under the test conditions used in this study.³

³ Tanvir S, Anderson WA. 2020. Antimicrobial Activity of "Deeply Scratched" Aereus Thermal Fabrication Surfaces. Department of Medical Engineering. University of Waterloo. 2020.

CLOSED CASE CARTS

Our Closed Case Carts come in a wide range of sizes with flexible shelving options, ergonomic doors, smart design choices, safety features, superior maneuverability, and optional accessories. They are robust and durable yet lightweight thanks to our one-piece body-wrap design of 18-gauge stainless steel.

All closed case carts are backed by an outstanding **7 year warranty** on structural and all components (excluding casters) with one year labor included.

KEY FEATURES

SMART DESIGN

- Top surface has a drip-proof ledge for spill drainage, while 5 degree sloped bottom pan and perforated chassis aid in drainage.
- The external welded handle maximizes interior storage.
- The outer door lock feature allows you to keep an open door position during washing, loading and unloading.



ERGONOMIC DOOR ASSEMBLIES

- Strong double pan design features bottom edge drainage holes (outside positioning)
- Heavy gauge hinge assemblies are easily removed for cleaning/adjustment
- SteriLock spring loaded door latch prevents accidental opening during transportation
- Include external push-pull handle for safe locking



OPTIONAL FEATURES

- Choose optional card holders, paddle latch assembly and retractable tow system assembly.

FLEXIBLE SHELVING

- Adjustable open shelf design provides additional shelf width and depth for large containers.
- Shelves types include solid, perforated or wired slide out featuring roll-out integral stops to prevent tipping during use.

SAFETY FEATURES

- Full perimeter bumper made from high temperature resistant rubber provides impact protection.
- Permanently sealed seams and crevices prevents water accumulation and sources of contamination.



SUPERIOR MANEUVERABILITY FEATURES

- Each cart features two all-swivel, one steer-lock, and one total-lock caster to facilitate easy steering, handling, and positioning.
- Stainless steel caster body is cart washer compatible and provides a high load rating of 225 lbs per wheel.



ACCESSORIES

ITEM #	DESCRIPTION
OR-3875	CARD HOLDER 6" W x 4"H (152mm x 102mm)
OR-3876	CARD HOLDER 9" W x 11" H (229mm x 279mm)
OR-3877	SECURITY / RING-SEAL BRACKETS
OR-3881	PUSH / PULL HANDLE
OR-3871-S	PADDLE LATCH ASSEMBLY SMALL
OR-3871-L	PADDLE LATCH ASSEMBLY LARGE
OR-3840	SOLID SLIDE-OUT SHELF 24" W x 24" H - Only for single door models
OR-3841	PERFORATED SLIDE-OUT SHELF 24" W x 24" H - Only for single door models
OR-3843	WIRE SLIDE-OUT SHELF 24" W x 24" H - Only for single door models
OR-3845	SOLID SLIDE-OUT SHELF 24" W x 36" H - Only for double door models
OR-3846	PERFORATED SLIDE-OUT SHELF 24" W x 36" H - Only for single door models
OR-3848	WIRE SLIDE-OUT SHELF 24" W x 36" H - Only for single door models



PRODUCT SELECTION

ITEM #	DESCRIPTION	DIMENSIONS (L x W x H) IN / MM	CAPACITY (CU. FT.) *
OR-3810	SINGLE DOOR / STANDARD HEIGHT	Shelf: 24" x 24" (610 mm x 610 mm) Cabinet: 27" x 25 1/2" x 33" (686 mm x 648 mm x 838 mm) Overall: 33 1/4" x 28" x 39 1/2" (845 mm x 711 mm x 1003 mm)	11.5
OR-3815	SINGLE DOOR / TALL DESIGN	Shelf: 24" x 24" (610 mm x 610 mm) Cabinet: 27" x 25 1/2" x 48" (686 mm x 648 mm x 1219 mm) Overall: 33 1/4" x 28" x 54 1/2" (845 mm x 711 mm x 1384 mm)	16.5
OR-3820	DOUBLE DOOR / STANDARD HEIGHT	Shelf: 36" x 24" (914 mm x 610 mm) Cabinet: 39" x 25 1/2" x 33" (991 mm x 648 mm x 838 mm) Overall: 45 1/4" x 28" x 39 1/2" (1149 mm x 711 mm x 1003 mm)	16.6
OR-3825	DOUBLE DOOR / TALL DESIGN	Shelf: 36" x 24" (914 mm x 610 mm) Cabinet: 39" x 25 1/2" x 48" (991 mm x 648 mm x 1219 mm) Overall: 45 1/4" x 28" x 54 1/2" (1149 mm x 711 mm x 1384 mm)	24.2



OPEN CASE CARTS

Our Open Case Carts are built to last using Series 300 stainless steel with a #4 polished finish and come in two versatile sizes and three heights with flexible shelving options, smart design choices, important safety features, and superior maneuverability. The tubular design offers maximum rigidity, and the frame assembly is structurally supported by a heavy gauge fully welded chassis assembly for maximum load bearing capacity.

All open case carts are backed by an outstanding **7 year warranty** on structural and all components (excluding casters) with one year labor included.

KEY FEATURES

FLEXIBLE SHELVING

- Adjustable open shelf design provides additional shelf width and depth for large containers and can be easily removed/repositioned on the cross supports in 5" (127 mm) increments
- Shelves are available in solid or perforated stainless steel and are die-formed for maximum load bearing capacity

SMART DESIGN

- Work height carts have a fully welded solid top surface with perimeter channel supports for structural integrity
- Externally mounted integrally welded push-pull handle maximizes interior storage space
- All welds and joints are polished and blended for a smooth finish

SAFETY FEATURES

- Full perimeter bumper made from high temperature resistant rubber provides impact protection
- Standard corner bumpers are available as an option
- Permanently sealed seams and crevices prevents water accumulation and sources of contamination
- All surfaces are smooth and free from sharp edges that may result in sterile pack damage or worker injury



SUPERIOR MANEUVERABILITY

- Each cart features two all-swivel, one steer-lock, and one total-lock caster to facilitate easy steering, handling, and positioning
- Stainless steel caster body is cart washer compatible and provides a high load rating of 225 lbs per wheel
- Optional retractable linkage/training assembly provides for easy manual cart training/towing





PRODUCT SELECTION

FEATURES	OR-3920 & OR-3921-PS (add suffix A, B or C to item # to adjust features' specifications)		
	-A	-B	-C
OVERALL HEIGHT	39 1/2" (1003 mm)	39 1/2" (1003 mm)	54" (1372 mm)
CAPACITY (CU. FT)	16.6	23.9	28.9
SHELF SUPPORT POSITION	3	3	3
CASTERS SIZE	5" (127 mm)	5" (127 mm)	8" (203 mm)
OVERALL DIMENSION	45 1/4" L x 28" W (1149 mm x 711 mm)		
SHELF DIMENSION	36 1/4" L x 24" W (921 mm x 610 mm)		

Item # OR-3921-PS has perforated shelves

ACCESSORIES

ITEM #	DESCRIPTION
OR3982	BUMPER ASSEMBLY FLUSH MOUNT



UTILITY CARTS

Our Utility Carts are built to last using heavy-gauge grade 18-8 stainless steel and come in four versatile models for general purpose transport/storage use of supplies, instruments, or equipment in the Operating Room, trauma, emergency or minor procedure area.

All utility carts are backed by our **1 year warranty** on structural and all components (excluding casters).

KEY FEATURES

SMART DESIGN

- Fully welded and polished to a #4 finish
- Spill-proof 1 inch (51 mm) lip on three sides of top surface and middle shelf
- Non-marking bumpers on push/pull handle and front corners of the cart
- **Reinforcing steel rod** is secured below the top shelf for **added strength and stability**
- **Steel plate** is affixed underneath all shelves to prevent wobble and bottoming-out



OR-3692F

SUPERIOR MANEUVERABILITY

- Each cart features high load rating swivel casters that are mounted to heavy-duty chassis base frame
- Push/pull handle runs the full width of the cart and is positioned for ease of use

PRODUCT SELECTION

ITEM #	SHELF SIZE (W x L)	SHELF CLEARANCE	OVERALL HEIGHT	CASTER DIAMETER	LOAD CAPACITY
OR-3692A	15 1/2" x 24" (394 mm x 610 mm)	12" (305 mm)	32" (813 mm)	3" (76 mm)	200 lbs (91 kg)
OR-3692B	17 3/4" x 30" (451 mm x 762 mm)	11 3/4" (298 mm)	32" (813 mm)	3" (76 mm)	200 lbs (91 kg)
OR-3692D	17 3/4" x 30" (451 mm x 762 mm)	12 1/8" (308 mm)	33 1/4" (845 mm)	4" (102 mm)	400 lbs (182 kg)
OR-3692F	20 3/4" x 35" (527 mm x 889 mm)	13 1/2" (343 mm)	37 1/8" (943 mm)	5" (127 mm)	500 lbs (224 kg)
OR-3692-WO*	19" x 31" (483 mm x 787 mm) Area 4.2 SQ FT (0.4 SQ M) Volume: 12 CU FT (0.3 CU M) Weight: 42 lbs. (19.1 kg)	Customizable	34" (864 mm)	4" (102 mm)	500 lbs (181 kg)

*Three sides have 1" high raised edge on top and middle shelf.

NOTE: Due to continual product development, specifications are subject to change without notice.



ANESTHESIA CARTS

Our Anesthesia Cart is a flexible storage system for the various anesthesia supplies, medications, and instrumentation required in the operating room. Built to last in stainless steel 304 with a #4 polish, it is easy to clean and maintain.

All anesthesia carts are backed by our **1 year warranty** on structural and all components (excluding casters).

KEY FEATURES

SMART DESIGN

- Comes complete with six full extension drawer assemblies in various depths: 3 x 3" (76 mm), 2 x 6" (152 mm), 1 x 9" (228 mm)
- Smooth surface with a three-sided guard rail
- Over bridge assembly with optional accessory bins and/or shelf provides easily accessible additional storage space

SUPERIOR MANEUVERABILITY

- Caster assemblies with high load bearing capacity and grey non-marking rubber tires provide superior maneuverability
- Full perimeter bumper assembly protects cart body during transport

PRODUCT SELECTION

ITEM #	DESCRIPTION	DIMENSIONS (L x W x H)
OR-3680	ANAESTHESIA CART	27" X 22" X 40" (686 mm x 559 mm x 1016 mm)



OR-3680

Products shown in Anaesthesia Cart not included

ACCESSORIES

ITEM #	DESCRIPTION
OR-3680-DV3	DIVIDER KIT for 3" / 76 mm drawer
OR-3680-DV6	DIVIDER KIT for 6" / 152 mm drawer
OR-3680-GH	GLOVE BOX HOLDER
OR-3680-NC3	NARCOTIC CABINET WITH LOCK inside 3" / 76 mm drawer
OR-3680-NC6	NARCOTIC CABINET WITH LOCK inside 6" / 152 mm drawer
OR-3680-OR	OVERHEAD RAIL ASSEMBLY FOR BINS Complete with 2 lateral supports
OR-3680-PB	POWER BAR, HOSPITAL GRADE Complete with 10 ft / 3 M cord
OR-3680-SH	OVERHEAD SHELF ASSEMBLY 26" L x 10" W / 660 mm L x 254 mm W
OR-3680-SR	SIDE RAIL BRACKET
OR-3680-VS	VELCRO STRAP / BRACKET KIT



INSTRUMENT/ SUPPLY CABINET

Our Instrument/Supply Cabinets are designed to provide enclosed storage for O.R. supplies, medications, instrumentation, and apparatus.

All Instrument/Supply Cabinets are backed by our **1 year warranty** on structural and all components.

KEY FEATURES

- Cabinets come with four easily adjustable shelves (on 1" / 25 mm increments) and are fully interchangeable with other instrument/supply cabinets of similar width
- Standard sliding glass doors are framed in stainless steel and provide quick access to cabinet contents (optional door systems available)
- Cabinets are 22" / 559 mm deep x 84" / 2134 mm high at front
- Optional sloped top section adds 9 ½" / 241 mm to overall cabinet height
- Optional depth cabinets of 17 ¾" / 450 mm are available upon request



OR-3782

PRODUCT SELECTION

ITEM #	DESCRIPTION
OR-3782-A	INSTRUMENT/SUPPLY CABINET Width: 47" (1194 mm)
OR-3782-B	INSTRUMENT/SUPPLY CABINET Width: 35" (889 mm)
OR-3782-C	INSTRUMENT/SUPPLY CABINET Width: 24" (610 mm)
OR-3782-GH	HINGED GLASS DOORS
OR-3782-RF	RECESSED FLANGE KIT
OR-3782-ST	SLOPED TOP SECTION



INSTRUMENT TABLES

Our Instrument Tables come in six versatile models and are an economical back table for instruments or dressings. Fully welded heavy gauge stainless steel construction polished to a #4 finish provides excellent rigidity and extended product life.

All instrument tables are backed by an outstanding **7 year warranty** on structural and all components (excluding casters).

KEY FEATURES

- Channel support sub-frame for maximum weight capacity and structural rigidity
- Fully welded seamless tubular legs H-frame supports or lower shelf assembly
- Non-marking swivel design casters come in 2" (51 mm) or 3" (76 mm) depending on table size
- All models are 34" (864 mm) high and feature a lower shelf
- Open tubular base design is available upon request (reference # OR-3643)

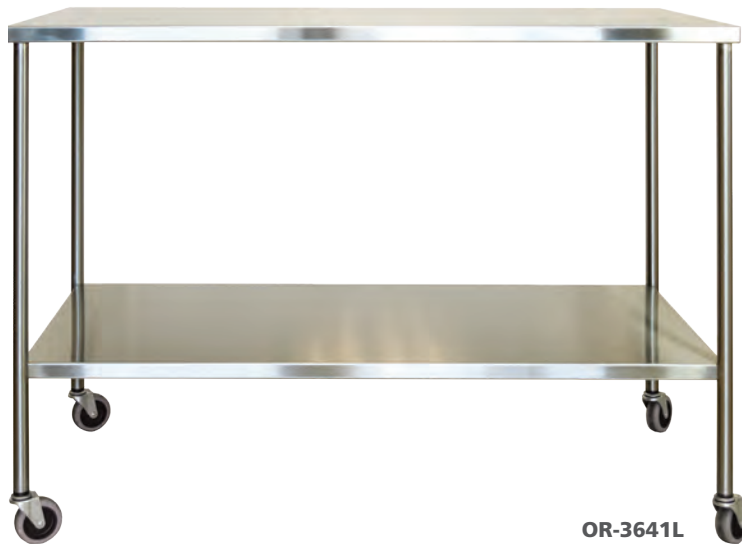

PRODUCT SELECTION

ITEM #	DIMENSIONS (L x W)
OR-3641A	20" x 16" (506 mm x 406 mm)
OR-3641B	30" x 16" (762 mm x 406 mm)
OR-3641C	34" x 18" (864 mm x 457 mm)
OR-3641D	36" x 20" (914 mm x 508 mm)
OR-3641H*	46" x 24" (1168 mm x 610 mm)
OR-3641L*	58" x 24" (1473 mm x 610 mm)

*H and L models supplied with 3" / 76 mm caster assemblies

ACCESSORIES

ITEM #	DESCRIPTION
OR-3641X-R3	THREE-SIDED GUIDE RAIL Assembly for Table Top or Lower Shelf (Specify size)
OR-3641X-R4	FOUR-SIDED GUIDE RAIL Assembly for Table Top or Lower Shelf (Specify size)
OR-3640	DRAWER ASSEMBLY Inside Dimensions: 15" L x 16 3/4" W x 3 3/4" D (381 mm x 426 mm x 95 mm)

EQUIPMENT TABLES

Our Equipment Tables come in three sizes and are a sterile and efficient solution for organizing and storing equipment and supplies. Fully welded heavy gauge stainless steel construction is easy to clean and maintain.

All equipment tables are backed by our **1 year warranty** on structural and all components (excluding casters).

KEY FEATURES

- All models include stainless steel welded drawer liners, a lower shelf, and three -sided ribbon rail
- Heavy-duty conductive swivel casters come in 2" (51 mm) or 3" (76 mm) depending on table size



PRODUCT SELECTION

ITEM #	DESCRIPTION (L x W x H)
OR-3644	EQUIPMENT/INSTRUMENT TABLE WITH TWO DRAWERS, GUARD RAIL, AND LOWER SHELF 36" x 18" x 34" (914 mm x 457 mm x 864 mm)
OR-3648	EQUIPMENT/INSTRUMENT TABLE WITH ONE DRAWER, GUARD RAIL, AND LOWER SHELF 20" x 18" x 34" (508 mm x 457 mm x 864 mm)
OR-3650	ANESTHETIST'S TABLE WITH THREE DRAWERS (2 X 4"/102MM DEEP, 1 X 8"/204MM DEEP), GUARD RAIL, AND LOWER SHELF 20" x 18" x 34" (508 mm x 457 mm x 864 mm)

MAYO STANDS

Our Mayo Stands come in seven models and are a great choice for general clinical use and operating room applications. The stainless steel seamless tubular construction is fully welded and polished for ease of cleaning and maximum structural support.

All mayo stands are backed by an outstanding **7 year warranty** on structural and all components (excluding casters).

KEY FEATURES

- Auto-clutch height adjustment system automatically locks tray at desired height and provides for smooth raising and lowering
- Safety mechanism prevents the tray frame from unexpectedly dropping
- Casters are ball bearing swivel 2" (51 mm) diameter
- All models feature a tray height adjustment range of 38" to 58" (965 mm to 1473 mm)

STAINLESS STEEL TRAYS ARE POLISHED, AND DIE-FORMED WITH RADIUS CORNERS. THEY COME IN TWO STANDARD SIZES

PRODUCT SELECTION

ITEM #	DESCRIPTION	TRAY SIZE (L X W)
OR-3657	EMERGENCY MAYO STAND WITH 4 CASTER BASE, AND T-LOCK Manually Operated	19"x13" (483 mm x 330 mm)
OR-3658	STANDARD TRAY Push-Button Sled-Type Base and Auto-Clutch System	19"x13" (483 mm x 330 mm)
OR-3662	LARGE TRAY Push-Button Sled-Type Base and Auto-Clutch System	21"x16" (533 mm x 406 mm)
OR-3660	STANDARD TRAY Manually Operated with Two Casters Sled-Type Base and T-Lock Handle	19"x13" (483 mm x 330 mm)
OR-3661	LARGE TRAY Manually Operated with Two Casters Sled-Type Base and T-Lock Handle	21"x16" (533 mm x 406 mm)
OR-3665	STANDARD TRAY Foot-Operated Mayo Stand Sled-Type Base and Foot Release Auto-Clutch System	19"x13" (483 mm x 330 mm)
OR-3666	LARGE TRAY Foot-Operated Mayo Stand Sled-Type Base and Foot Release Auto-Clutch System	21"x16" (533 mm x 406 mm)

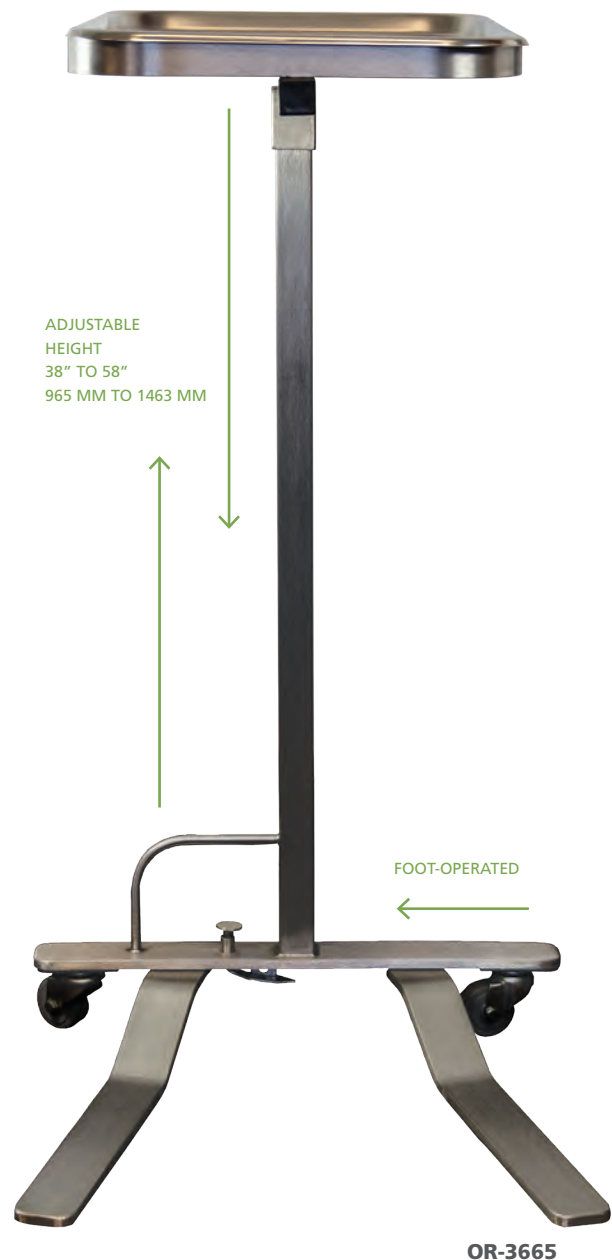

OR-3665

STRADDLE (NEUROSURGERY) TABLES

Our Straddle (Neurosurgery) Tables come in four lengths and are a convenient height-adjustable instrument table for cases involving many instruments and/or diagnostic equipment. Heavy-duty polished stainless steel construction with fully welded tubular support base.

All straddle (neurosurgery) tables are backed by our **1 year warranty** on structural and all components (excluding casters).

KEY FEATURES

- Direct-action drive mechanism provides smooth adjustment with no creeping or slippage
- Optional accessories include stainless steel extension shelves and marine-edge spill proof stainless steel work surface
- Feature four 3" (76 mm) grey non-marking casters (2 with swivel, 2 with brake)
- Height-adjustable from 36" to 58" (914 mm to 1473 mm) with stainless steel collapsible crank handle
- All models feature a standard 27.5" (700 mm) minimum clearance between the vertical leg supports



OR-3646X

Standard 27 1/2" / 700 mm minimum clearance between the vertical leg supports

PRODUCT SELECTION

ITEM #	DESCRIPTION
OR-3646X	STRADDLE TABLE, WITH STANDARD POSITION CRANK HANDLE Available lengths: A: 24" / 610 mm B: 32" / 813 mm C: 40" / 1016 mm D: 46" / 1168 mm

Add suffix to Model # for work surface length required.
Standard Table / Extension Shelf width is 34" / 864 mm.

Stainless steel extension shelves and marine-edge work surfaces are available as optional features.

ACCESSORIES

ITEM #	DESCRIPTION
OR-3646ES	STAINLESS STEEL EXTENSION SHELF Available lengths: 4" and 8" / 102 mm and 203 mm depending on table width
OR-3646LH	LOWER POSITION CRANK HANDLE ASSEMBLY
OR-3646ME-X	MARINE-EDGE SPILL PROOF STAINLESS STEEL WORK SURFACE



LINEN INSPECTION TABLES

Our Linen Inspection Tables provide a large, LED illuminated work surface for the inspection of linen drapes and packing wraps. Available in 2 sizes and constructed from stainless steel with a sealed translucent plexiglass work surface. The stainless steel frame and legs ensures durability for extended product life.

All linen inspection tables are backed by our **1 year warranty** on structural and all components (excluding casters).

KEY FEATURES

- LED fixtures provide bright, consistent lighting, are power efficient and last longer than traditional bulbs
- Optional lower shelf provides extra storage space
- Tubular legs are available with optional heavy-duty grey non-marking casters with brakes
- Features height adjustable levelers
- CSA Approved hospital grade power cord (10 feet / 3 meters) and light switch
- Easily accessible lamp assembly for bulb replacement
- Service required: 120V, 60Hz

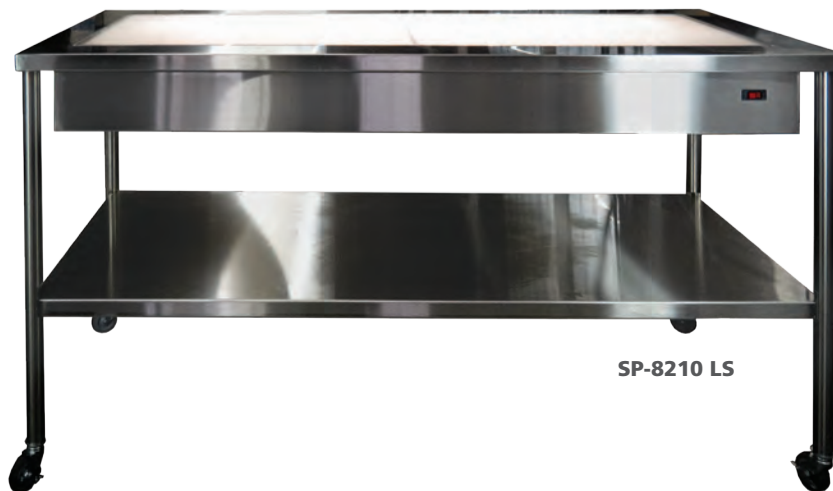

SP-8210 LS

PRODUCT SELECTION

ITEM #	DESCRIPTION	DIMENSIONS (L x W x H)
SP-8210 LS	LINEN INSPECTION TABLE WITH LOWER SHELF (Standard Length)	72"x 32"x 36" (1829 mm x 813 mm x 914 mm)
SP-8210	LINEN INSPECTION TABLE (Standard Length)	72"x 32"x 36" (1829 mm x 813 mm x 914 mm)
SP-8215	CASTER KIT FOR STANDARD TABLE (Set of Four) Factory Installed	
SP-8220	LINEN INSPECTION TABLE (Extended Length)	92"x 32"x 36" (2337 mm x 813 mm x 914 mm)
SP-8220 LS	LINEN INSPECTION TABLE WITH LOWER SHELF (Standard Length)	92"x 32"x 36" (2337 mm x 813 mm x 914 mm)
SP-8225	CASTER KIT FOR EXTENDED TABLE (Set of Six)	



UTILITY INSPECTION TABLE

Our Utility Inspection Tables facilitate the assembly, inspection, and packing of instruments and/or equipment before or after the decontamination and sterilization process. All table components are built to last using heavy gauge Series 300 Grade 18-8 stainless steel and are die-formed, fully welded, and polished to a #4 blended finish.

All Utility Inspection Tables are backed by our **1 year warranty** on structural and all components.

KEY FEATURES

- Rigid channel support design and tubular leg cross bracing ensures maximum stability, high load capacity, and extended product life
- Countertop is supported with die-formed stainless steel channels and integrally welded to the tubular leg frame base assembly
- Tables feature height adjustable stainless steel bullet feet
- Optional drawer assemblies, full length lower shelf, and overshelf assemblies provide flexible storage configurations
- Optional drawer assemblies are die-formed stainless steel with a double pan drawer front and heavy-duty ball bearing slide assemblies
- Custom sizes and designs are available upon request



SP-8724

PRODUCT SELECTION

ITEM #	DESCRIPTION
SP-8710	UTILITY INSPECTION TABLE WITH TUBULAR LEG ASSEMBLY Length available: 44" / 1118 mm
SP-8720	UTILITY INSPECTION TABLE WITH TUBULAR LEG ASSEMBLY Length available: 60" / 1524 mm
SP-8730	UTILITY INSPECTION TABLE WITH TUBULAR LEG ASSEMBLY Length available: 76" / 1930 mm
SP-8740	UTILITY INSPECTION TABLE WITH TUBULAR LEG ASSEMBLY Length available: 92" / 2337 mm
SP-8712	OVERSHELF ASSEMBLY WITH MOUNTING KIT Length available: 44" / 1118 mm
SP-8722	OVERSHELF ASSEMBLY WITH MOUNTING KIT Length available: 60" / 1524 mm
SP-8732	OVERSHELF ASSEMBLY WITH MOUNTING KIT Length available: 76" / 1930 mm
SP-8742	OVERSHELF ASSEMBLY WITH MOUNTING KIT Length available: 92" / 2337 mm
SP-8714	MODULAR DRAWER WITH FOUR SIDED APRON ASSEMBLY Length available: 44" / 1118 mm
SP-8724	MODULAR DRAWER WITH FOUR SIDED APRON ASSEMBLY Length available: 60" / 1524 mm
SP-8734	MODULAR DRAWER WITH FOUR SIDED APRON ASSEMBLY Length available: 76" / 1930 mm
SP-8744	MODULAR DRAWER WITH FOUR SIDED APRON ASSEMBLY Length available: 92" / 2337 mm

KERRI BEAR MATERNITY BASSINET™

The Kerri Bear Maternity Bassinet™ is easy to handle and clean, making it the ideal choice for hospitals looking for a versatile, safe, stylish, and long-lasting bassinet.

PRODUCT COMPONENTS

- Infant carrier
- Integrated changing table
- Spacious lower storage cabinet available in 5 colours: Designer White, Silverpine, Featherstone, Shadow Blue, and Mauve Blush

KEY FEATURES

ANTIMICROBIAL COATING

- Manufactured with our specialized lead-free, antibacterial protective powder paint coating*
- Prevents the spread of dangerous micro-organisms and suppresses the growth of mold and bacteria**
- Durable coating resists chipping and discoloration

BASSINET BASKET

- Frame and carrier are fully welded and painted with a baked protective anti-bacterial powder coating
- Carrier frame accommodates three basket positions: Neutral, Trendelenburg, and Reverse Trendelenburg
- Basket carrier can be easily adjusted back to reveal a convenient changing table underneath (pull safety switch)
- Safety switch mechanism locks basket carrier in place to prevent movement during transport

BASE CABINET

- Easy-pull handles and magnetic catches for easy door opening and secure door closing
- Fabricated from easy to disinfect high-quality materials (no wood or laminate components used)
- Large storage space for quick access to supplies and materials with optional shelf available



* Antibacterial paint specifications available upon request
 ** Laboratory documentation available upon request

MATTRESSES

- Two mattresses available: one for basket and one for changing table
- Mattresses made from fire retardant, antibacterial medium density foam material for infant support and comfort
- Changing table features a three-sided guard rail to ensure mattress is secured/ prevent sliding



CASTERS

- Heavy duty 3" (76 mm) non-marking grey rubber casters facilitate excellent maneuverability of the bassinet
- 2 x Swivel and 2 x Total Lock



CASTERS

DIMENSIONS (L x W x H)

OVERALL SIZE	32.5" x 19.5" x 37.75" 826 mm x 495 mm x 959 mm	CHANGING TABLE MATTRESS	31" x 18.5" x 1" 787 mm x 470 mm x 25 mm
ACRYLIC BASKET	27.5" x 13.5" x 9.5" (Head End) 700 mm x 340 mm x 241 mm	BASKET MATTRESS	26" x 12.5" x 2" 660 mm x 318 mm x 50 mm
STORAGE CABINET (INTERIOR)	31" x 18" x 20" 787 mm x 457 mm x 508 mm		

PRODUCT SELECTION

ITEM #	COLOUR	
PH-2695WH	DESIGNER WHITE	
PH-2695SP	SILVERPINE	
PH-2695FS	FEATHERSTONE	
PH-2695SB	SHADOW BLUE	
PH-2695MB	MAUVE BLUSH	

ACCESSORIES

ITEM #	DESCRIPTION (L x W x H)
1 PH-2657	MATERNITY BASKET WITH CARD HOLDER High impact seamless acrylic clear Size: 27.5" x 13.5" x 9.5" / 698.5 mm x 342.9 mm x 241.3 mm Card Holder Size: 5" x 3.5
2 PH-2659	BASKET MATTRESS Fire retardant anti-bacterial Size: 26" x 12.5" x 2" / 660.4 mm x 317.5 mm x 50.8 mm
3 PH-2658	CHANGING TABLE MATTRESS Fire retardant anti-bacterial Size: 31" x 18.5" x 1" / 787.4 mm x 469.9 mm x 25.4 mm
4 PH-2672	INTERIOR CABINET WITH OPTIONAL SHELF Not adjustable
5 12008	CASTER 3" ALL SWIVEL All surface
5 12009	CASTER 3" WHEEL LOCK All surface, wheel lock
6 PH-2660	JAR RACK White only
7 PH-2661D	BASIN HOLDER, AND STAINLESS STEEL BASIN
8 PH-2671	CHART HOLDER

Find the images for the Items codes through the document



FOR EVERY NEW KERRI BEAR
BASSINET™ SOLD,
A DONATION OF \$10 WILL
BE MADE TO THE MISSING
CHILDREN'S NETWORK³.

3. Imperial Surgical has established special arrangements with the respective charity.

WE OFFER ONE OF THE BEST WARRANTIES IN THE INDUSTRY

All Imperial Surgical Kerri Bear Bassinets™ are warranted to be free from defects in workmanship and materials for a period of **seven years from date of original purchase**.

Accessories which are not manufactured by Imperial Surgical are warranted from defects in workmanship for one year.



STAINLESS STEEL MATERNITY BASSINET

Our stainless steel maternity bassinet is an economical bassinet for use in the operating room and/or maternity suite. The fully welded tubular frame construction provides maximum strength and facilitates easy cleaning and extended product life.

Our stainless steel maternity bassinet is backed by an outstanding **7 year warranty** on structural and all components (excluding casters) with one year labor included.

KEY FEATURES

- Modular frame allows for several storage designs including Trendelenburg positioning from either end of the frame
- Clear PVC infant basket features air/drainage holes and card holder
- Basket mattress is wrapped in a fire-retardant Med-Stat antibacterial covering
- Heavy duty 3" (76 mm) non-marking grey rubber casters (2 x Swivel and 2 x Total Lock)
- Lightweight design is easy to maneuver



TRENDELENBURG
POSITIONING
→



PRODUCT SELECTION

ITEM #	DESCRIPTION (L x W x H)
PH-2655	TUBULAR FRAME MATERNITY BASSINET 33" x 17" x 38" (838 mm x 432 mm x 965 mm)
PH-2657	MATERNITY BASKET WITH CARD HOLDER High impact seamless acrylic clear Size: 27.5" x 13.5" x 9.5" / 698.5 mm x 342.9 mm x 241.3 mm Card Holder Size: 5" x 3.5"
PH-2659	BASKET MATTRESS Fire retardant anti-bacterial Size: 26" x 12.5" x 2" / 660.4 mm x 317.5 mm x 50.8 mm

STACKABLE STEP STOOLS

Made of lightweight cast aluminium and protected with an antimicrobial powder coating, our patented Stackable Step Stools have been designed with infection prevention as a prime focus.



PRODUCT FEATURES

- Weight: 8.3 lbs (3.8 kg)
- Dimensions: 17.4" L x 13" W x 4.7" H (44.2 cm L x 33 cm W x 11.9 cm H)
- Transport Cart Available
- Weight Capacity: 300 lb (136 kg)
- Warranty: 7 years (step stool only)

ANTIMICROBIAL COATING:

Prevents the spread of hazardous microorganisms and suppresses the growth of mold, bacteria, yeast, and mildew.

ANTI-SLIP SURFACE:

Provides enhanced stability.

RUBBER-FREE CORNERS:

Avoids fluid collection.

WASHABLE CART:

Model OR-36364 (without mat) can be sterilized.

HYGIENIC DESIGN:

No welds or large hollow openings to trap debris or fluids.

PRODUCT SELECTION

ITEM #	DESCRIPTION	COLOR
OR-36363	Stackable Step Stool with mat	Black
OR-36363-02	Stackable Step Stool with mat	Dark Blue
OR-36363-03	Stackable Step Stool with mat	Green
OR-36363-07	Stackable Step Stool with mat	Orange
OR-36364	Stackable Step Stool without mat	N/A

Packaging: Sold by Unit

REPLACEMENT PARTS

ITEM #	DESCRIPTION	PACKAGING
OR-36363-1A	Replacement Mat for OR-36363	1 Unit
OR-36363-1B	Replacement Foot Pegs	1 Unit

OPTIONAL ACCESSORIES

ITEM #	DESCRIPTION	PACKAGING
OR-3693	Transport cart	1 Unit
809-1705	Reusable Anti-Fatigue Mat with adhesive strips to secure it in place	5 / Box
899-1710	Single-Use Anti-Fatigue Mat with adhesive strips to secure it in place	10 / Box



OR-3693

CHAIRS & STOOLS

Our Chairs & Stools revolve and are an economical solution for an operating room or clinical application. Available with and without upholstery in four models. Stainless steel construction facilitates easy clean-up and extended product life. Fully welded stainless steel seamless tubular frame construction with a #4 polished finish.

All chairs & stools are backed by our **1 year warranty** on structural and all components (excluding casters).

KEY FEATURES

- Wide base provides added stability especially when used with optional casters
- Stainless steel 13" (330 mm) diameter seat with optional backrest
- Upholstered 14" (356 mm) diameter seats feature 2" (51 mm) dual density foam core and antibacterial conductive double stitched vinyl cover
- Integrally welded stainless steel foot ring for maximum strength and comfort
- Heavy-duty threaded spindle and bracket assembly provide easy height adjustment and rigid support
- Choose between non-marking conductive swivel design 2" (51 mm) casters or conductive rubber crutch tips



OR-3620



OR-3622

PRODUCT SELECTION

ITEM #	DESCRIPTION
OR-3620	STAINLESS STEEL REVOLVING STOOL Height adjustment 19" to 27" (483 mm to 686 mm)
OR-3621	STAINLESS STEEL REVOLVING STOOL Height adjustment 25" to 32" (635 mm to 813 mm)
OR-3622	REVOLVING STOOL WITH UPHOLSTERED SEAT, AND STAINLESS STEEL BASE Height adjustment 19" to 27" (483 mm to 686 mm)
OR-3623	REVOLVING STOOL WITH UPHOLSTERED SEAT, AND STAINLESS STEEL BASE Height adjustment 25" to 32" (635 mm to 813 mm)

ACCESSORIES

ITEM #	DESCRIPTION
OR-3628	CASTER ASSEMBLY WITH SOCKET KIT
OR-3629	CONDUCTIVE SEAT COVER, AND PAD FOR 13" / 330 MM DIAMETER STAINLESS STEEL STOOL SEATS

FOOT STOOLS

Our Foot Stools are available in a variety of configurations for a full range of applications in the operating room. Durable stainless steel fully welded construction provides maximum strength and facilitates easy clean-up and extended product life.

All foot stools are backed by our **1 year warranty** on structural and all components.

KEY FEATURES

- Single or double non-slip rubber tread surfaces with flared leg design for superior stability
- Heavy gauge stainless steel platform base with die-formed edge
- Seamless welded tubular frame leg support with conductive rubber crutch tips
- Fully welded assembly



PRODUCT SELECTION

ITEM #	DIMENSIONS (L x W x H)
OR-36360	16" x 12" x 8" (406 mm x 305 mm x 203 mm)
OR-36360-B	24" x 12" x 8" (610 mm x 305 mm x 203 mm)
OR-36360-E	30" x 12" x 8" (762 mm x 305 mm x 203 mm)

Add suffix -H to Item # to add a Stainless Handrail

FIRST AID COUCH

Our First Aid Couch is a general-purpose treatment couch with a full-length vinyl upholstered top section featuring a contoured head support area and a dual density foam core for maximum comfort and support.

KEY FEATURES

- Vinyl material is sulphide stain resistant and meets standard flame resistance requirements
- Full welded tubular leg frame assembly with height adjustable levelling feet (sub-assembly required)
- Custom colours available: Aqua Green, Colonial Blue, Mauve (note: all custom colours may require a set-up charge, subject to availability and volume)



ET-1574

EXAMINATION CHAIRS & STOOLS

Our general-purpose examination chairs and stools feature a pneumatic assist gas cylinder and stable five leg base.

KEY FEATURES

BASE

- Five leg, 22"/ 559 mm diameter base assembly
- Reinforced nylon resin base with steel collar for maximum stability

CASTERS

- 2"/51 mm dual wheel general purpose casters for tile or carpet surfaces

SEAT HEIGHT

- Adjustable by pneumatic cylinder with dual nylon wheel

UPHOLSTERY

- Double density 3"/76 mm foam upholstered top
- 15 ¾"/ 400 mm diameter seat
- Vinyl material is sulphide stain resistant with a high abrasion resistance factor and meets standard flame resistance requirements



ET-1955

OPTIONAL FEATURES

- Three cylinder seat height configurations from 16"/406 mm to 32"/ 813 mm
- Adjustable backrest depth is fully adjustable (moved front or back)
- Adjustable footring assembly for tall cylinder configurations
- Safety Casters

PRODUCT SELECTION

ITEM #	DESCRIPTION
ET-1574	FIRST AID COUCH
ET-1955	STANDARD HEIGHT EXAM CHAIR/STOOL
ET-1960	TALL EXAM CHAIR/STOOL
ET-1961	ADJUSTABLE BACKREST FOR STOOL
ET-1970	LOCKING CASTERS set of 5

All couches, chairs & stools are backed by our **1 year warranty** on structural and all components (excluding casters).

BOWL STANDS & RECEPTACLES

Our Bowl Stands and Receptacles are designed for convenience, mobility, and durability. Available in five versatile models that accommodate most standard sizes of stainless steel bowls and pails. Fully welded stainless steel construction throughout with a #4 polished finish.

All bowl stands are backed by an outstanding **7 year warranty** on all parts (see warranty for details).

KEY FEATURES

- Seamless welded tubular frame with lower cross-bracing provides maximum rigidity and extended product life
- Optional lower stainless steel shelf is available for all configurations
- Non-marking conductive swivel design 2" (51 mm) casters

PRODUCT SELECTION

ITEM #	DESCRIPTION
OR-36310	SPONGE RECEPTACLES: FLOOR UNITS Mobile Kick Bucket with Qt. Pail and Perimeter Bumper Receptacle: 14.5" Ø x 8" H / 368 mm Ø x 203 mm H Receptacle and bucket: 14.5" Ø x 15" H / 368 mm Ø x 381 mm H Bucket: 12" Ø x 11" H / 305 mm Ø x 279 mm H
OR-3632	MOBILE SPONGE RECEPTACLES with 10 Qt. Oval Basin and Perimeter Bumper
OR-3631-TB	SPONGE RECEPTACLES: TABLE HEIGHT Mobile Table Height Receptacle with 20 Qt. Pail 15" L x 16" W x 38" H (381 mm x 406 mm x 965 mm)
OR-3651	SPONGE RECEPTACLES: TABLE HEIGHT Single Bowl Stand with 7 Qt. Basin 15" L x 16" W x 34" H (381 mm x 406 mm x 864 mm)
OR-3652	SPONGE RECEPTACLES: TABLE HEIGHT Double Bowl Stand with Two 7 Qt. Basins 33" L x 16" W x 34" H (838 mm x 406 mm x 864 mm)



OR-3651-LS

THE LOWER SHELF IS AN OPTIONAL FEATURE THAT MUST BE ADDED TO THE ITEM IF DESIRED

ACCESSORIES

ITEM #	DESCRIPTION
OR-3631-PS	12 QT. STAINLESS STEEL PAIL for OR-36310
OR-3631-TB-PS	20 QT. STAINLESS STEEL PAIL for OR-3631-TB
OR-3632-BS	10 QT. OVAL STAINLESS STEEL BASIN for OR 3632
OR-3651-BS	7 QT. STAINLESS STEEL BASIN for OR-3651 and OR-3652

Add suffix -LS to any Item # to add a lower shelf

GRADUATED MEASURING

PRODUCT SELECTION

ITEM #	DESCRIPTION (Ø x H)
H-0201	300 CC (10 OZ) 83 mm x 114 mm
H-0202	500CC (16 OZ) 96 mm x 124 mm
H-0203	1000 CC (32 OZ) 128 mm x 134 mm
H-0204	2000 CC (64 OZ) 151 mm x 172 mm



H-0201

H-0203

GALLIPOTS

PRODUCT SELECTION

ITEM #	DESCRIPTION (Ø x H)
H-0361	GALLIPOT, 2 OZ 65 mm x 35 mm
H-0362	GALLIPOT, 4 OZ 77 mm x 45 mm
H-0363	GALLIPOT, 6 OZ 83 mm x 50 mm
H-0364	GALLIPOT, 10 OZ 95 mm x 55 mm
H-0365	GALLIPOT, 14 OZ 112 mm x 58 mm
H-0366	GALLIPOT, 8 OZ 90 mm x 50 mm
H-0367	GALLIPOT, 12 OZ 103 mm x 60 mm



H-0361

H-0363

All Imperial Ware products are backed by our 1 year warranty.



IMPERIAL WARE, STANDS & RECEPTACLES

WASH BASINS & BOWLS



H-0321

PRODUCT SELECTION

ITEM #	DESCRIPTION (Ø x H)
H-1228	WASH BASIN, SHALLOW TYPE, 12.5" 320 mm x 80 mm
H-1229	WASH BASIN, DEEP TYPE, 12.5" 320 mm x 105 mm
H-1230	WASH BASIN, DEEP TYPE, 13.375" 340 mm x 100 mm
H-1231	WASH BASIN, DEEP TYPE, 14.4" 365 mm x 115 mm
H-0301	BOWL, 10 CM, 3/8 QT, 14 OZ 108 mm x 50 mm
H-0302	BOWL, 12 CM, 5/8 QT, 20 OZ 133 mm x 56 mm
H-0303	BOWL, 14 CM, 1 QT, 32 OZ 145 mm x 60 mm
H-0304	BOWL, 16 CM, 1 3/8 QT, 44 OZ 167 mm x 70 mm
H-0305	BOWL, 18 CM, 1 7/8 QT, 60 OZ 185 mm x 70 mm
H-0321	SOLUTION BOWL, 4 QT, 128 OZ 330 mm x 84 mm
H-0322	SOLUTION BOWL, 5 1/8 QT, 164 OZ 308 mm x 110 mm
H-0323	SOLUTION BOWL, 7 QT, 224 OZ Ø 355 mm x 115 mm



H-0302

FOOD SERVICE CONTAINERS



H-0802

PRODUCT SELECTION

ITEM #	DESCRIPTION (L x W x H)
H-0801	FOOD SERVICE CONTAINER, FULL SIZE 530 mm x 320 mm x 65 mm
H-0801P	PERFORATED FOOD SERVICE CONTAINER, FULL SIZE 530 mm x 320 mm x 65 mm
H-0802	FOOD SERVICE CONTAINER, FULL SIZE 530 mm x 320 mm x 100mm
H-0802P	PERFORATED FOOD SERVICE CONTAINER, FULL SIZE 530 mm x 320 mm x 100mm
H-0803	COVER FOR FOOD SERVICE CONTAINER, FULL SIZE 533 mm x 325 mm x 35 mm
H-0807	FOOD SERVICE CONTAINER, 1/2 SIZE 321 mm x 262 mm x 65 mm
H-0807P	PERFORATED FOOD SERVICE CONTAINER, 1/2 SIZE 321 mm x 262 mm x 65 mm
H-0808	FOOD SERVICE CONTAINER, 1/2 SIZE 321 mm x 262 mm x 100 mm
H-0808P	PERFORATED FOOD SERVICE CONTAINER, 1/2 SIZE 321 mm x 262 mm x 100 mm
H-0809	COVER FOR FOOD SERVICE CONTAINER, 1/2 SIZE 324 mm x 265 mm x 32 mm



H-0801P



H-0808P

All Imperial Ware products are backed by our 1 year warranty.



INSTRUMENT TRAYS

SHALLOW

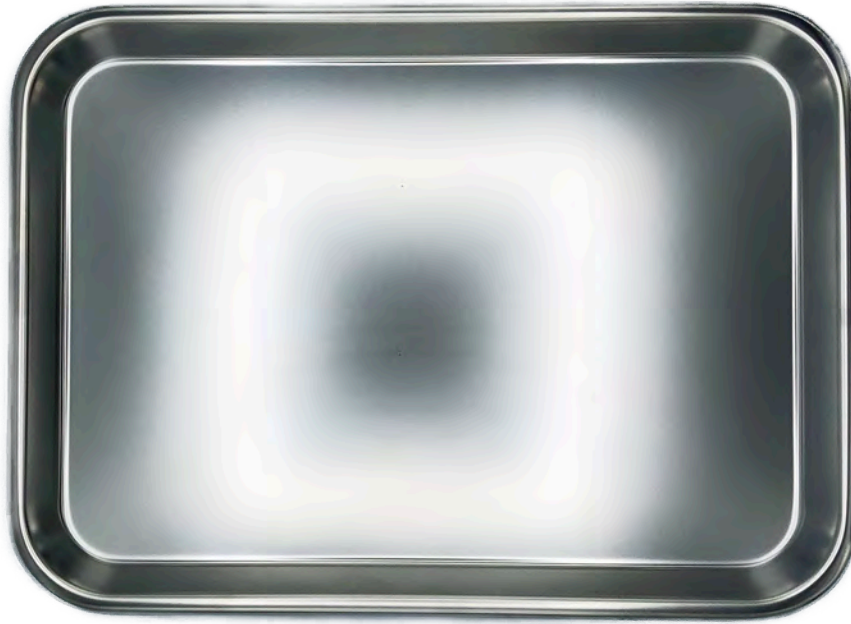

H-0557



H-0553



H-0558

PRODUCT SELECTION

ITEM #	DESCRIPTION (L x W x H)
H-0553	INSTRUMENT TRAY 210 mm x 110 mm x 8 mm
H-0554	SHALLOW RECTANGULAR TRAY 217 mm x 128 mm x 12 mm
H-0556	SHALLOW RECTANGULAR TRAY 225 mm x 162 mm x 14 mm
H-0557	SHALLOW RECTANGULAR TRAY 285 mm x 185 mm x 17 mm
H-0558	SHALLOW RECTANGULAR TRAY 338 mm x 245 mm x 17 mm
H-0559	SHALLOW RECTANGULAR TRAY 390 mm x 271 mm x 18 mm
H-0559P	PERFORATED SHALLOW TRAY 390 mm x 271 mm x 18 mm
H-0560	SHALLOW RECTANGULAR TRAY 440 mm x 295 mm x 18 mm
H-0560P	PERFORATED SHALLOW TRAY 440 mm x 295 mm x 18 mm
H-0561	SHALLOW RECTANGULAR TRAY 491 mm x 322 mm x 18 mm

All Imperial Ware products are backed by our **1 year warranty**.

INSTRUMENT TRAYS

DEEP & PERFORATED



H-0563

PRODUCT SELECTION

ITEM #	DESCRIPTION (L x W x H)
H-0562	DEEP RECTANGULAR TRAY 292 mm x 195 mm x 50 mm
H-0563	DEEP RECTANGULAR TRAY 335 mm x 246 mm x 55 mm
H-0563P	PERFORATED RECTANGULAR TRAY 335 mm x 246 mm x 55 mm
H-0564	DEEP RECTANGULAR TRAY 387 mm x 272 mm x 60 mm
H-0564P	PERFORATED DEEP RECTANGULAR TRAY 387 mm x 272 mm x 60 mm
H-0565	DEEP RECTANGULAR TRAY 445 mm x 281 mm x 97 mm
H-0565P	PERFORATED DEEP RECTANGULAR TRAY 445 mm x 281 mm x 97 mm
H-0566	DEEP RECTANGULAR TRAY 501 mm x 336 mm x 101 mm



H-0565



H-0562

All Imperial Ware products are backed by our 1 year warranty.



CATHETER & INSTRUMENT TRAYS



H-0153



H-0156



H-0159

PRODUCT SELECTION

ITEM #	DESCRIPTION
H-0151	CATHETER & INSTRUMENT TRAY (NO COVER)
H-0152	COVER FOR H-0151
H-0153	CATHETER & INSTRUMENT TRAY SET (WITH COVER, RAISED HANDLE) 219 mm L x 81 mm W x 35 mm H
H-0154	CATHETER & INSTRUMENT TRAY (NO COVER)
H-0155	COVER FOR H-0154
H-0156	CATHETER & INSTRUMENT TRAY SET (WITH COVER, RAISED HANDLE) 231 mm L x 132 mm W x 49 mm H
H-0157	CATHETER & INSTRUMENT TRAY (NO COVER)
H-0158	COVER FOR H-0157
H-0159	CATHETER & INSTRUMENT TRAY SET (WITH COVER, RAISED HANDLE) 320 mm L x 95 mm W x 50 mm H



CATHETER & INSTRUMENT TRAYS

PRODUCT SELECTION

ITEM #	DESCRIPTION
H-0160	CATHETER & INSTRUMENT TRAY (NO COVER)
H-0160P	PERFORATED CATHETER & INSTRUMENT TRAY (NO COVER)
H-0161	COVER FOR H-0160 AND H-0160P
H-0162	CATHETER & INSTRUMENT TRAY SET (WITH COVER, FLUSH HANDLE) 310 mm L x 196 mm W x 50 mm H
H-0163	CATHETER & INSTRUMENT TRAY (NO COVER)
H-0163P	PERFORATED CATHETER & INSTRUMENT TRAY (NO COVER)
H-0164	COVER FOR H-0163 AND H-0163P
H-0165	CATHETER & INSTRUMENT TRAY SET (WITH COVER, FLUSH HANDLE) 310 mm L x 196 mm W x 65 mm H
H-0166	CATHETER & INSTRUMENT TRAY (NO COVER)
H-0167	COVER FOR H-0166
H-0168	CATHETER & INSTRUMENT TRAY SET (WITH COVER, RAISED HANDLE) 441 mm L x 116 mm W x 45 mm H



H-0162



H-0165



H-0168



All Imperial Ware products are backed by our 1 year warranty.

URINALS & BEDPANS



H-0102



H-0108



H-0109

PRODUCT SELECTION

ITEM #	DESCRIPTION
H-0101	ADULT BEDPAN WITHOUT COVER 355 mm x 290 mm x 50 mm
H-0102	ADULT BEDPAN WITH COVER 355 mm x 165 mm
H-0105	FRACTURE BEDPAN (LONG COVER) 310 mm x 245 mm
H-0106	FRACTURE BEDPAN (SHORT COVER) 355 mm x 290 mm x 50
H-0107	MALE URINAL (VERTICAL TYPE) 110 mm x 230 mm
H-0108	MALE URINAL (HORIZONTAL TYPE) 110 mm x 230 mm
H-0109	FEMALE URINAL 124 mm x 125 mm x 216 mm
H-0111	ADULT BEDPAN WITH 2 HANDLES, RIGHT & LEFT 110 mm x 230 mm
H-0112	ADULT BEDPAN WITH 2 HANDLES, FRONT & BACK 110 mm x 230 mm

All Imperial Ware products are backed by our 1 year warranty.

JARS & COVERS

PRODUCT SELECTION

ITEM #	DESCRIPTION (Ø x H)
H-0391	NEEDLE OR OINTMENT JAR WITH COVER (RAISED HANDLE) 76 mm x 63 mm
H-0392	NEEDLE OR OINTMENT JAR WITH COVER (RAISED HANDLE) 95 mm x 65 mm
H-0393	DRESSING JAR WITH COVER (FLUSH HANDLE) 90 mm x 110 mm
H-0394	DRESSING JAR WITH COVER (FLUSH HANDLE) 102 mm x 80 mm
H-0395	DRESSING JAR WITH COVER (FLUSH HANDLE) 102 mm x 130 mm
H-0396	DRESSING JAR WITH COVER (FLUSH HANDLE) 123 mm x 130 mm
H-0397	DRESSING JAR WITH COVER (FLUSH HANDLE) 123 mm x 166 mm
H-0398	DRESSING JAR WITH COVER (FLUSH HANDLE) 180 mm x 180 mm
H-0399	DRESSING JAR WITH COVER 62 mm x 82 mm
H-0400	DRESSING JAR WITH COVER (FLUSH HANDLE) 82 mm x 100 mm
H-1214	FORCEP JAR WITH HANDLE, 60 MM 65 mm x 100 mm
H-1215	FORCEP JAR WITH HANDLE, 75 MM 82 mm x 123 mm
H-1216	FORCEP JAR WITH HANDLE, 90 MM 98 mm x 145 mm
H-1217	FORCEP JAR WITH HANDLE, 100 MM 105 mm x 170 mm
H-1218	FORCEP JAR, 50 MM 55 mm x 80 mm



H-0398



H-1215

All Imperial Ware products are backed by our 1 year warranty.



PETRI DISHES

H-1223

H-1224

H-1226

H-1227



H-1225

PRODUCT SELECTION

ITEM #	DESCRIPTION (Ø x H)
H-1223	PETRI DISH WITH COVER 60 mm x 20 mm
H-1224	PETRI DISH WITH COVER 75 mm x 20 mm
H-1225	PETRI DISH WITH COVER 90 mm x 17 mm
H-1226	PETRI DISH WITH COVER 90 mm x 20 mm
H-1227	PETRI DISH WITH COVER 120 mm x 20 mm

All Imperial Ware products are backed by our 1 year warranty.

EMESIS BASINS



H-0262

PRODUCT SELECTION

ITEM #	DESCRIPTION (Ø x W x H)
H-0261	EMESIS BASIN, 6" WITHOUT COVER 172 mm x 96 mm x 34 mm
H-0262	COVER FOR H-0261 175 mm x 100 mm x 7 mm
H-0264	EMESIS BASIN, 8" WITHOUT COVER 208 mm x 98 mm x 36 mm
H-0265	COVER FOR H-0264 210 mm x 100 mm x 7 mm
H-0267	EMESIS BASIN, 10" WITHOUT COVER 256 mm x 119 mm x 45 mm
H-0268	COVER FOR H-0267 260 mm x 125 mm x 7 mm
H-0270	EMESIS BASIN, 12" WITHOUT COVER 310 mm x 152 mm x 55 mm
H-0271	COVER FOR H-0270 315 mm x 155 mm x 10 mm



H-0261



IMPERIAL WARE, STANDS & RECEPTACLES

All Imperial Ware products are backed by our 1 year warranty.

CUPS, TUMBLERS, AND PITCHERS



H-0342

H-0352



H-0381



H-0502

PRODUCT SELECTION

ITEM #	DESCRIPTION (Ø x H)
H-0341	MEDICINE CUP, 1 OZ 48 mm x 30 mm
H-0342	MEDICINE CUP, 2 OZ 52 mm x 50 mm
H-0351	IODINE CUP, 2 OZ 60 mm x 30 mm
H-0352	IODINE CUP, 6 OZ 83 mm x 55 mm
H-0353	IODINE CUP, 14 OZ 120 mm x 60 mm
H-0381	TUMBLER, 5 OZ 65 mm x 75 mm
H-0382	TUMBLER, 7 OZ 77 mm x 80 mm
H-1233	TUMBLER, 10 OZ 80 mm x 98 mm
H-0383	TUMBLER, 12 OZ 83 mm x 115 mm
H-0502	SOLUTION PITCHER, 1 QT 100 mm x 150 mm
H-0503	SOLUTION PITCHER, 2 QT 130 mm x 165 mm
H-0505	BELL-SHAPED PITCHER, 0.9 LT 150 mm x 170 mm
H-0506	BELL-SHAPED PITCHER, 1.8 LT 160 mm x 205 mm
H-0507	BELL-SHAPED PITCHER, 2.7 LT 195 mm x 226 mm

ANCILLARY ITEMS



H-0241



H-0233

PRODUCT SELECTION

ITEM #	DESCRIPTION (Ø x H)
H-0211	THERMOMETER / FORCEP JAR 27 mm x 102 mm
H-0212	THERMOMETER / FORCEP JAR 55 mm x 120 mm
H-0213	THERMOMETER / FORCEP JAR 55 mm x 190 mm
H-0232	TONGUE DEPRESSOR 22 mm x 170 mm
H-0233	TONGUE DEPRESSOR 23 mm x 190 mm
H-0241	TABLET COUNTING DISH L 215 mm x W 150 mm x H 135 mm



H-0212



H-0213

All Imperial Ware products are backed by our 1 year warranty.



CADAVER STRETCHER

Our Cadaver Stretcher is designed for careful and discreet transport. The stainless steel construction facilitates easy cleaning and decontamination and extended product life.

All cadaver stretchers are backed by our **1 year warranty** on structural and all components (excluding casters).

KEY FEATURES

- Features a lightweight removable canopy frame and vinyl covered canopy measuring 4" - 8" (10.2 cm – 20.3 cm)
- Complete circumference bumper provides protection
- 4 homa swiveling casters (2 x all swivel with directional lock, 2 x all swivel total break)

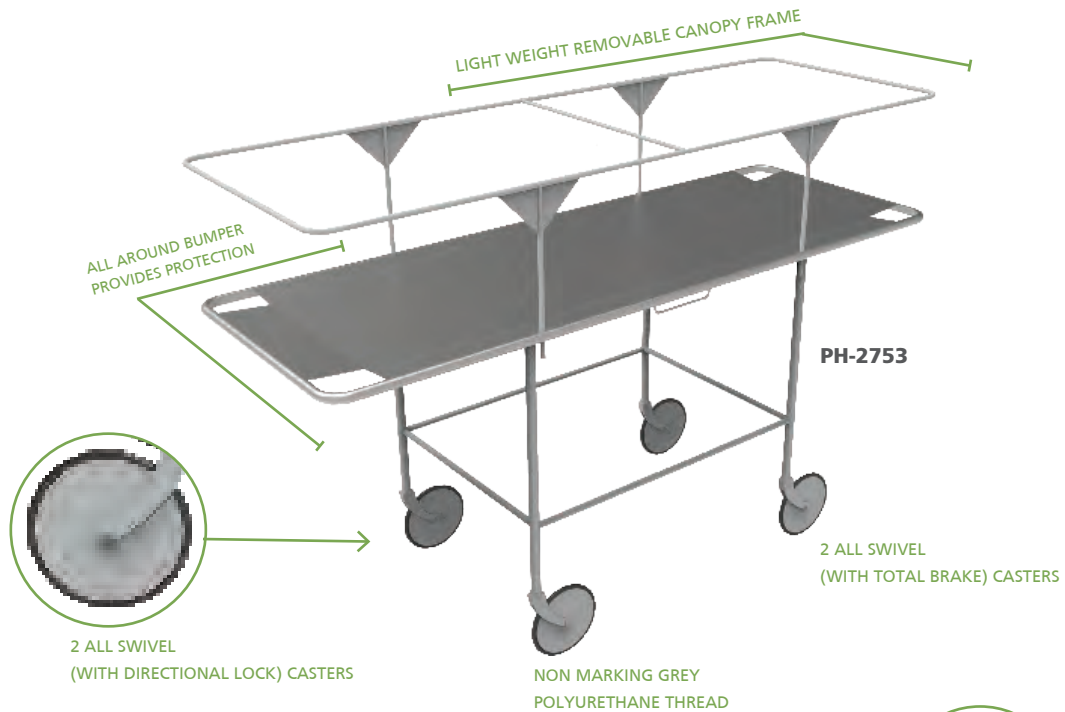

PRODUCT SELECTION

ITEM #	DESCRIPTION
PH-2753	CADAVER STRETCHER Stretcher and removable frame, vinyl covered canopy 8" (203 mm) Swivelling casters Holding weight capacity of 300 lbs
PH-2753HD	CADAVER STRETCHER - HEAVY DUTY Stretcher and removable frame, vinyl covered canopy 8" (203 mm) Swivelling casters Holding weight capacity of 650 lbs
12012	8" TOTAL BRAKES CASTERS With electrical resistance
12013	8" ALL SWIVEL DIRECTIONAL LOCK CASTERS With electrical resistance
13006-R0	COVER Thick resistant cover - Mint colour 75" L x 27" W x 17" D 1905 mm L x 686 mm W x 432 mm D

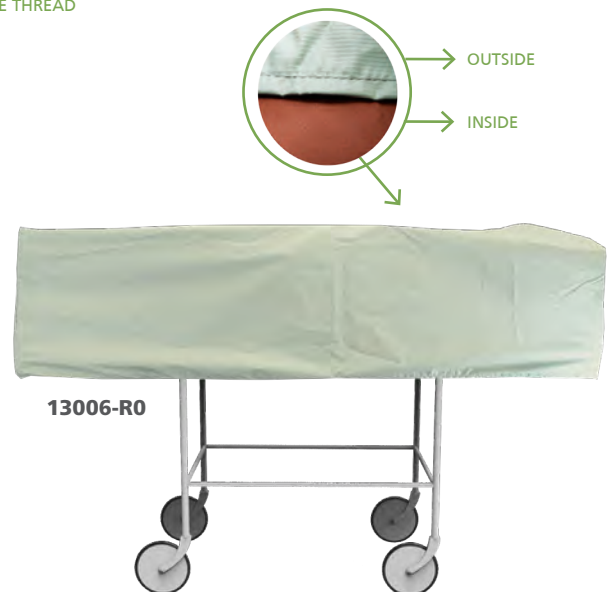

NARCOTIC CABINETS

Our Narcotic Cabinets provide secure storage of narcotic medications. Available in a range of sizes and configurations, they are designed for a secure mounting inside an existing cabinet or on the wall. The heavy gauge series 300 stainless steel construction provides extended product life, facilitates easy cleaning, and supports sterile storage.

All narcotic cabinets are backed by our **1 year warranty** on structural and all components.

KEY FEATURES

- Available in single or double door configurations with a variety of locking systems available
- Doors are permanently secured with a full-length piano hinge assembly welded to the cabinet body and include a standard heavy duty flush mount cam lock assembly individually keyed
- Include one fixed height stainless steel shelf with additional shelf systems available
- Optional features: warning lights and two or three position door lock assembly on outer door (larger designs)



ET-1694

PRODUCT SELECTION

ITEM #	DESCRIPTION (L x W x H)
ET-1694	SINGLE DOOR CABINET 12" x 6" x 12" (305 mm x 152 mm x 305 mm)
ET-1694-D	DOUBLE DOOR CABINET 12" x 8" x 12" (305 mm x 203 mm x 305 mm)
ET-1695	SINGLE DOOR CABINET 18" x 6" x 24" (457 mm x 152 mm x 610 mm)
ET-1695-D	DOUBLE DOOR SUPPLY CABINET 18" x 8" x 24" (457 mm x 203 mm x 610 mm)



ACCESSORIES

ITEM #	DESCRIPTION
ET-1690	TWO POSITION DOOR LOCK SYSTEM
ET-1691	TWO POSITION DOOR LOCK SYSTEM
ET-1693	WARNING LIGHT SYSTEM

CURTAIN AND CUBICLE TRACKS

We have a wide portfolio of curtain and cubicle tracks, all manufactured for maximum durability and ease of use. They come in a variety of models to suit a multitude of applications. Please ask your sales consultant for more information.

All curtain & cubicle tracks are backed by our **1 year warranty** on structural and all components.



IFC-100
ROLLER CARRIER



IFC-1000
IV-TRACK



IFC-1007
IV POLE CARRIER



IFC-50
SURFACE MOUNTED TRACK

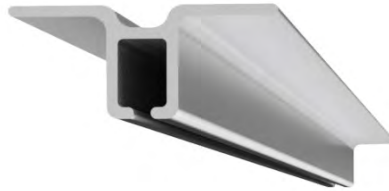

IFC-69
JIFFY - SURFACE MOUNTED TRACK



IFC-98
CUBICLE TRACK

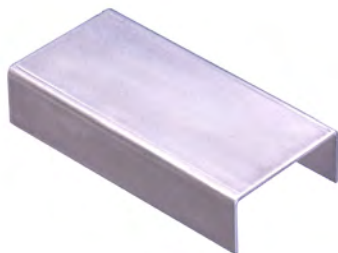

IFC-1009
SPLICE TO JOIN TRACK



IFC-1008
END STOP

RELTON-HALL SCOLIOSIS OPERATING FRAME

Our Relton-Hall Scoliosis Operating Frame is designed to support the patient in the prone position during corrective procedures for scoliosis. The frame has been designed to properly support patients weighing up to 275 lbs/125 kg.

Our Relton-Hall Scoliosis Operating Frame is backed by our **1 year warranty** on structural and all components.

KEY BENEFITS

- Provides lateral stability
- Reduces blood loss by keeping the anterior abdominal wall pendulous and free from external pressure
- Positioning on the antero-lateral supports facilitates correction of the scoliosis deformity
- Radiolucent supports allow for intraoperative imaging

KEY FEATURES

FRAME ASSEMBLY

- The frame consists of four well-padded vertical supports which are arranged in two V-shaped pairs
- Supports are arranged at a 35 degree inward tilt and are individually adjustable for length and width
- Three-point phenolic knobs with welded positioning attachments provide full adjustability
- Constructed from welded stainless steel for maximum patient support and radiolucent fiber-reinforced resin pad supports to allow for unobstructed visualization under imaging

SUPPORT PADS

- Removable
- Made from a dual density foam core and double stitched anti-bacterial vinyl covering
- Optional specially molded dry polymer pads for additional padding (assists with prevention of decubitus ulcers and necrosis which may result from procedures of extended duration)



PRODUCT SELECTION

ITEM #	DESCRIPTION	DIMENSIONS (L x W x H)
OR-6050	RELTON-HALL OPERATING FRAME WITH VINYL PAD SUPPORTS	OVERALL: 24" x 22" x 6 1/4" (610 mm x 559 mm x 159 mm) LENGTH ADJUSTMENT: 3 1/4" to 24" (83 mm to 610 mm) WIDTH ADJUSTMENT: 5 1/2" to 14 1/2" (140 mm to 368 mm)
OR-6050-P	VINYL PADS (SET OF FOUR) FOR OR-6050	6 1/2" x 5 1/4" x 3 1/2" (165 mm x 133 mm x 89 mm)
OR-6050-A	ACTION® PRODUCTS PRESSURE RELIEF PADS (SET OF 4) To be applied over vinyl pads.	

NOTE: The use of the Relton-Hall Operating Frame is not recommended during laminectomy for disc protrusion due to the lordotic position of the lumbar vertebrae resulting from this method of patient support.

STAINLESS STEEL SINKS, SINK STANDS, & SINK COUNTERS

We have a wide portfolio of stainless steel sinks and sink stands, all manufactured with heavy gauge stainless steel and a #4 polished finish for maximum durability, superior appearance, and extended product life.

Available models include Surgical Scrub Sinks, Utility Scrub Sinks, Wash Station/Sink Stands, and Sink Clean-up Counters. They come in a variety of sizes and styles to suit a multitude of applications. Please ask your sales consultant for more information.

All sinks, sink stands, & sink counters are backed by our **1 year warranty** on structural and all components.



OR-6130



SP-8410



OR-6220



SP-8415



OR-6110

ASK US ABOUT OUR AVAILABLE ACCESSORIES:

- SP-8440** RINSING FAUCET C/W SWING SPOUT
- SP-8441** DISTILLED WATER FAUCET
- SP-8448** STAINLESS STEEL OVERFLOW ASSEMBLY

KLEANIK INTEGRA™ & KLEANIK™ SINK DISINFECTION SYSTEM

It has been well documented that sink drains are a breeding ground for dangerous microorganisms. These microorganisms get disseminated through aerosols from water splashing into the sinks when they are used, causing the spread of nosocomial infections.

KLEANIK INTEGRA™ is a complete self-disinfecting sink station. Incorporating KLEANIK™ Automated Sink Drain Disinfection and an advanced, CSA Z-8000 compliant anti-microbial sink, KLEANIK INTEGRA™ offers protection against bacterial contamination from both the drain and the sink surface.

KLEANIK™ is a fully automatic system, which continuously cleans and disinfects the p-trap under the sink during normal operation. The KLEANIK™ technology virtually eliminates the risk of bacterial contamination from sink drains by:

- Preventing biofilm formation through electromechanical vibrations
- Continuously killing bacteria in sink drains through heat application
- Preventing the spread of aerosol borne infection



KLEANIK INTEGRA™



KLEANIK™

INTERESTED IN DISCUSSING OUR KLEANIK INTEGRA™
& KLEANIK™ SOLUTIONS?

ASK YOUR SALES CONSULTANT FOR MORE INFORMATION

WWW.IMPERIALSURGICAL.COM

SURGMED

GROUP 

Proudly Canadian, **The Surgmed™ Group of Companies** began operations in 1992 as a single distribution company known as **Advanced Surgi-Pharm Inc.** The company quickly became known as an industry leader and specialty distributor of value-added surgical products in the Canadian hospital market. Five years later, **Surgmed expanded upon its success with the launch of Batrik Medical Manufacturing Inc.** in 1997 and the subsequent acquisition of **Imperial Surgical Ltd.** one year later in 1998.

Together, our three unique companies serve the Canadian and global healthcare markets with high quality and competitively priced products, all backed by world-class customer care.



Founded in 1992, Advanced Surgi-Pharm Inc. is the distribution arm of Surgmed™ in Canada, representing leading US, international and domestic manufacturers for a wide range of specialty products with unique benefits for applications in the Operating Room, Women's Health, Labor & Delivery, ICU, and Sterile Processing areas. Equipped with a direct sales team, ASP provides effective nationwide coverage as the Canadian distributor of Batrik, Vygon, Rocket Medical, Cooper Surgical, SunMed, and other industry leading products including a wide-ranging portfolio of top-rated PPE products.

Established in 1997 and sold in 80 countries globally, Batrik Medical Manufacturing Inc. specializes in the manufacturing of endoscopy accessories, enzymatic solutions, infection control, central sterilization, and surgical devices. Batrik's in-house controlled environment production facility adheres to strictly enforced quality and regulatory control systems. They are registered as a device manufacturing establishment with the United States FDA and are in full compliance with CE and Health Canada Regulations. All Batrik products are rigorously tested, liability insured, and meet/exceed high international quality standards.

Established in 1935, Imperial Surgical Ltd. is one of Canada's oldest hospital capital equipment manufacturers, well-known for their stainless steel healthcare equipment for Sterile Processing, Operating Room, Examination and Treatment, Patient Handling, and Mortuary/ Pathology areas. Their growing portfolio of products also has applications in Infection Control & Prevention, an important area of focus for their future.



SURGMED GROUP

2165 46th Ave., Lachine, QC, Canada H8T 2P1

Phone: +1.514.631.7988 | Toll Free: 800.661.5432 | Fax: +1.514.631.9083

Email: info@surgmed.com | Website: www.imperialsurgical.com